

 CAMDENBOSS <small>CONNECT. ENCLOSE. INNOVATE.</small>		COLOUR: See Datasheet or Website	PROJECTION 	DRAWING UNITS: MILLIMETERS TOLERANCES: SEE CRITICAL DIMS	DO NOT SCALE DRAWING	SCALE 1:5
		FINISH: LIGHT SPARK	TITLE: 92 Series Size 32 COMMS BOX		SHEET 1 OF 2	
REV 01	COMPLETED BY M.Maciak	DATE 15/08/24	MATERIAL: ABS UL 94-V0	DWG NO: CDE9232xx -01	A4	

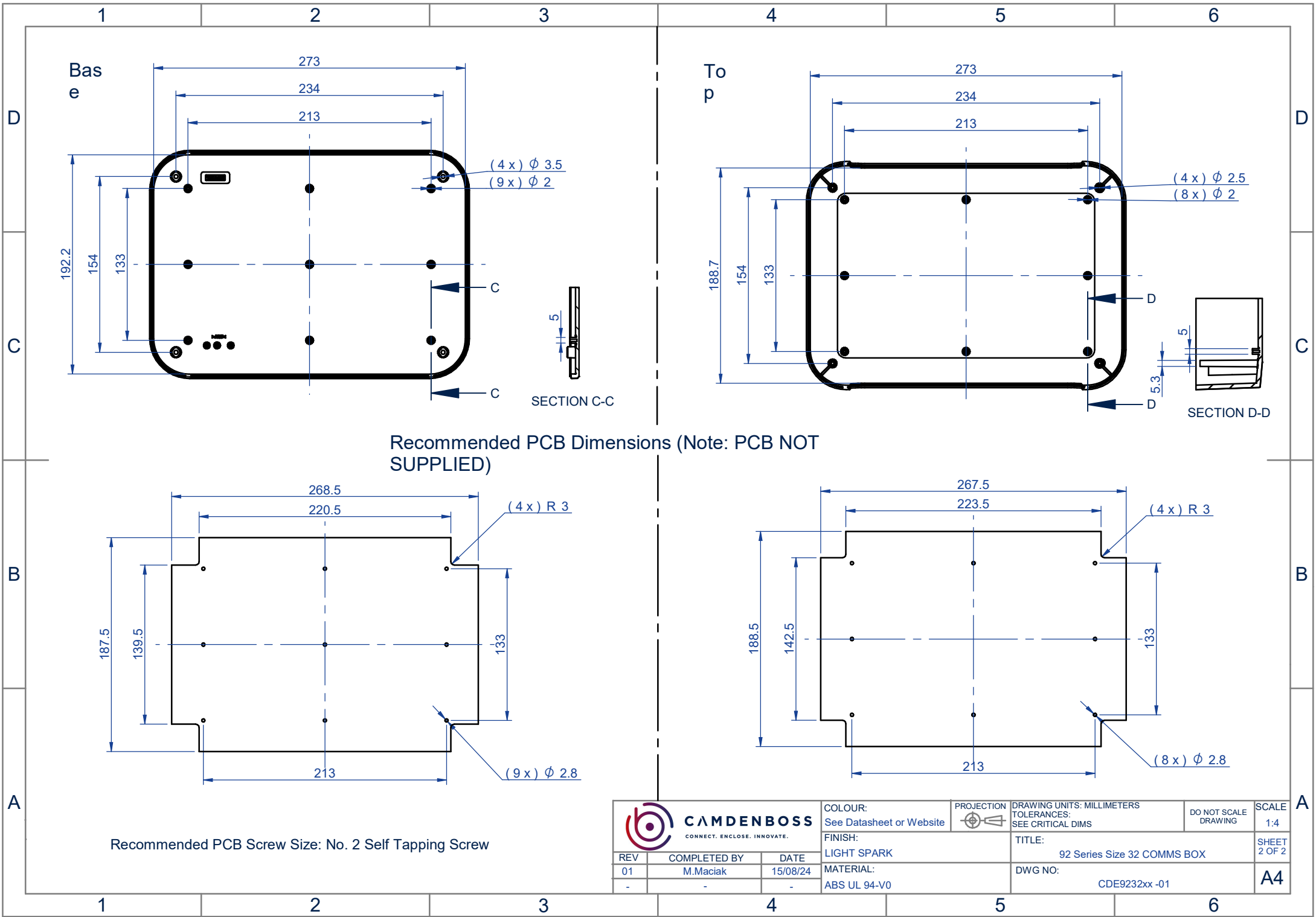

Recommended PCB Dimensions (Note: PCB NOT SUPPLIED)

Recommended PCB Screw Size: No. 2 Self Tapping Screw

 CAMDENBOSS <small>CONNECT. ENCLOSE. INNOVATE.</small>		COLOUR: See Datasheet or Website	PROJECTION 	DRAWING UNITS: MILLIMETERS TOLERANCES: SEE CRITICAL DIMS	DO NOT SCALE DRAWING	SCALE 1:4
		FINISH: LIGHT SPARK	TITLE: 92 Series Size 32 COMMS BOX		SHEET 2 OF 2	
REV 01	COMPLETED BY M.Maciak	DATE 15/08/24	MATERIAL: ABS UL 94-V0	DWG NO: CDE9232xx -01	A4	