



SECTION B-B

SECTION A-A

ISO VIEW
1:3

1:3

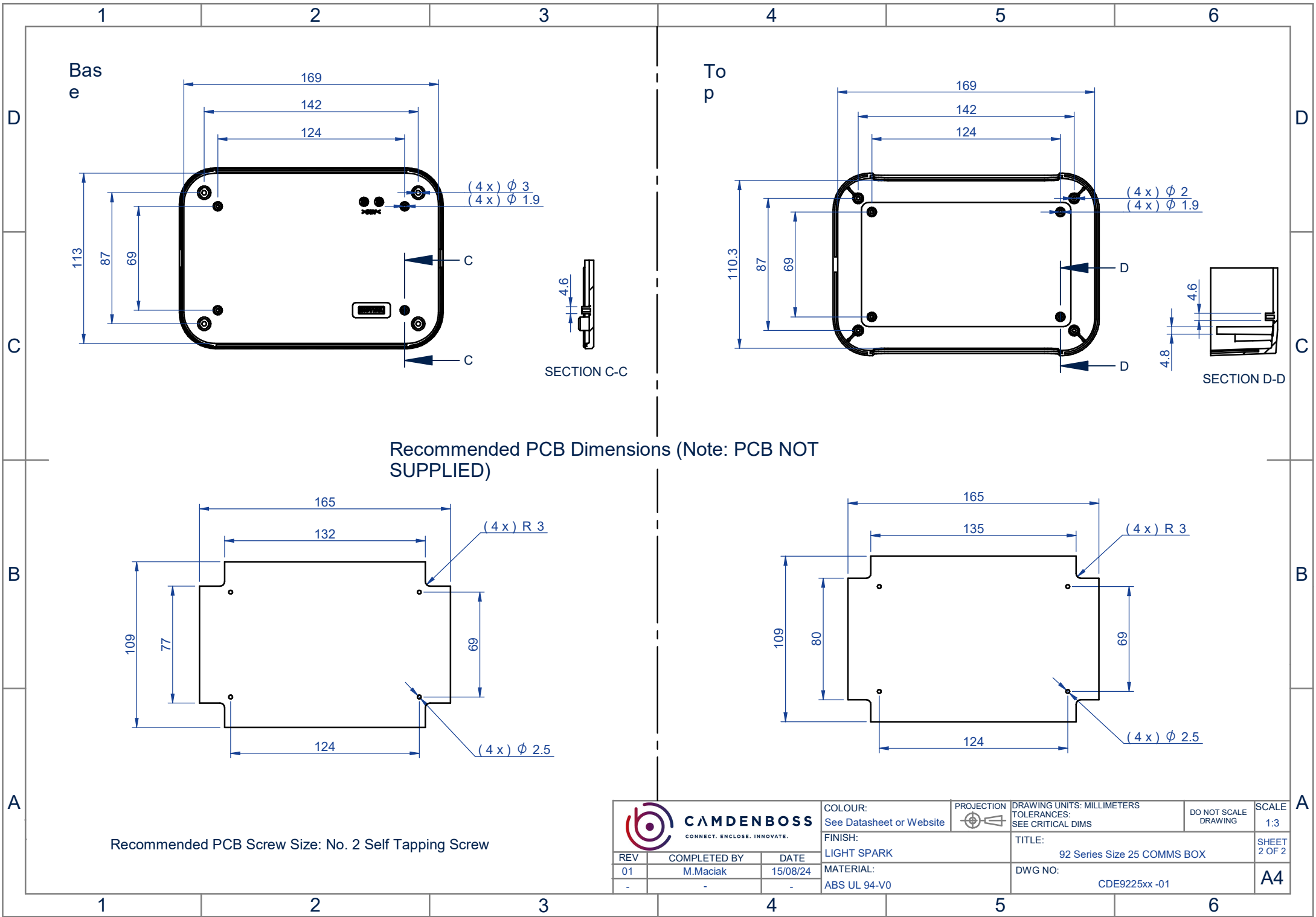

 CAMDENBOSS <small>CONNECT. ENCLOSE. INNOVATE.</small>		COLOUR: See Datasheet or Website	PROJECTION 	DRAWING UNITS: MILLIMETERS TOLERANCES: SEE CRITICAL DIMS	DO NOT SCALE DRAWING	SCALE 1:5
		FINISH: LIGHT SPARK	TITLE: 92 Series Size 25 COMMS BOX		SHEET 1 OF 2	
REV 01	COMPLETED BY M.Maciak	DATE 15/08/24	MATERIAL: ABS UL 94-V0	DWG NO: CDE9225xx -01	A4	

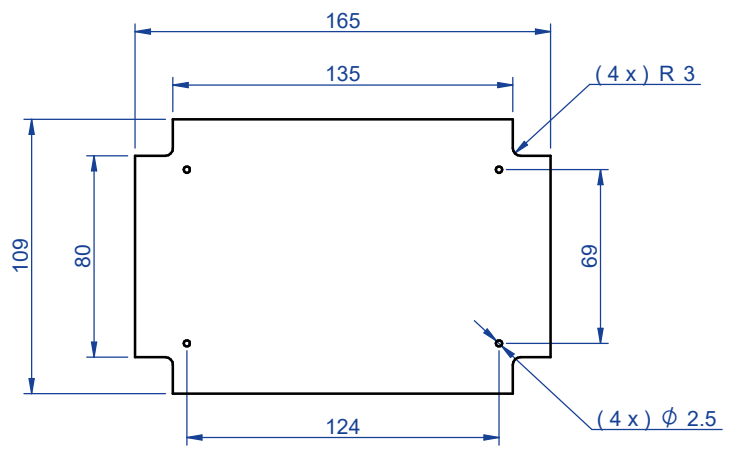
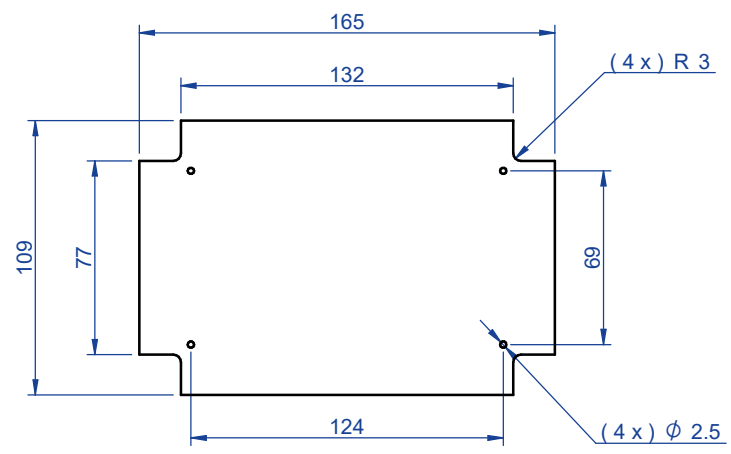

Recommended PCB Dimensions (Note: PCB NOT SUPPLIED)



Recommended PCB Screw Size: No. 2 Self Tapping Screw

 CAMDENBOSS <small>CONNECT. ENCLOSE. INNOVATE.</small>		COLOUR: See Datasheet or Website	PROJECTION 	DRAWING UNITS: MILLIMETERS TOLERANCES: SEE CRITICAL DIMS	DO NOT SCALE DRAWING	SCALE 1:3
		FINISH: LIGHT SPARK		TITLE: 92 Series Size 25 COMMS BOX		SHEET 2 OF 2
REV 01	COMPLETED BY M.Maciak	DATE 15/08/24	MATERIAL: ABS UL 94-V0		DWG NO: CDE9225xx -01	A4